

# PARMA 625 LED

astro

**GB** Products with electronic ballasts / drivers must not be installed on the same electrical circuits as products with inductive loads, for example magnetic fluorescent luminaires, motors or ventilators. Inductive loads can generate excessive voltage surges which can damage electronic ballasts.

The light source of this luminaire is not replaceable; when the light source reaches its end of life the whole luminaire shall be replaced.

PLEASE READ THE INSTRUCTIONS CAREFULLY  
BEFORE COMMENCING ASSEMBLY

Live: Normally Brown / Red  
Neutral: Normally Blue / Black  
Earth: Normally Green / Yellow

**FR** Les luminaires utilisant un ballast électronique / drivers ne peuvent être installés sur le même circuit que des appareils avec charges inductives, tels que luminaires fluorescents magnétiques, moteurs et ventilateurs. Les charges inductives peuvent générer des voltages excessifs et ainsi endommager les ballasts électroniques.

La source lumineuse de ce luminaire n'est pas remplaçable ; lorsque la source lumineuse atteint la fin de sa durée de vie le luminaire complet doit être remplacé.

LIRE ATTENTIVEMENT LES INSTRUCTIONS  
AVANT DE COMMENCER LE MONTAGE

Phase: Normalement Brun / Rouge  
Neutre: Normalement Bleu / Noir  
Terre: Normalement Vert / Jaune

**IT** Tutti i prodotti che includono ballast elettronici / driver non devono essere installati sugli stessi circuiti elettrici come anche prodotti con carichi induttivi quali lampadari a fluorescenza magnetica, motori o ventilatori. I carichi induttivi possono generare scariche eccessive che possono danneggiare i ballast.

I LED in questo apparecchio non sono sostituibili; quando i LED raggiungono la fine della loro vita l'apparecchio intero dovrà essere sostituito.

LEGGERE ATTENTAMENTE LE ISTRUZIONI  
PRIMA DI COMINCIARE L'ASSEMBLAGGIO

Cavo positivo: normalmente marrone o rosso  
Cavo neutro: normalmente blu o nero  
Cavo terra: normalmente verde o giallo

**DE** Produkte mit elektronischen Vorschaltgeräten/ Treibern dürfen nicht im selben Stromkreislauf installiert werden wie Verbraucher mit induktiven Lasten, z.B. magnetische Leuchtstofflampen, Motoren oder Ventilatoren. Induktive Lasten können übermäßige Spannungsspitzen erzeugen, die elektronische Vorschaltgeräte beschädigen könnten.

Die Lichtquelle dieser Leuchte ist nicht austauschbar. Wenn die Lichtquelle das Ende ihres Lebenszyklus erreicht hat, muss die ganze Leuchte ersetzt werden.

LESEN SIE BITTE DIE ANWEISUNGEN  
SORGFÄLTIG DURCH, BEVOR SIE MIT DEM  
ZUSAMMENBAUEN BEGINNEN

Phase: Normalerweise Braun / Rot  
Nulleiter: Normalerweise Blau / Schwarz  
Erde: Normalerweise Grün / Gelb

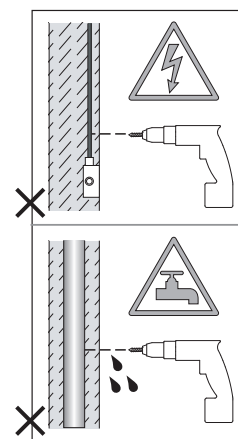

FOR WALL USE ONLY  
Usage mural uniquement  
Solo per uso a parete  
Nur zur Verwendung als Wandleuchte

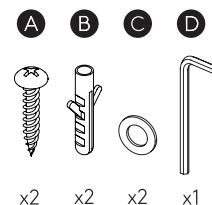
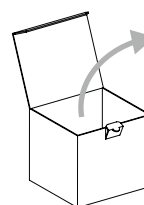
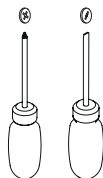
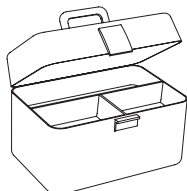

1

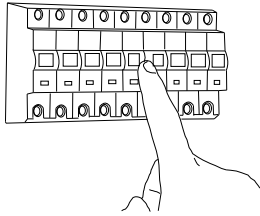

### TURN OFF POWER

Couper Le Courant! / Spegnere La Corrente! / Strom Abhalten!

2

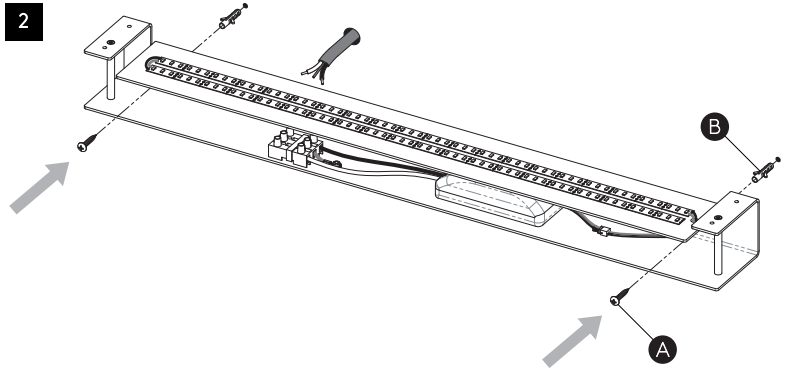

3a

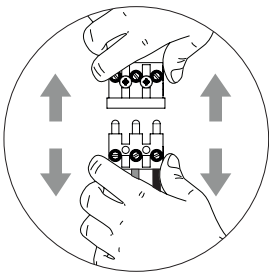

3b

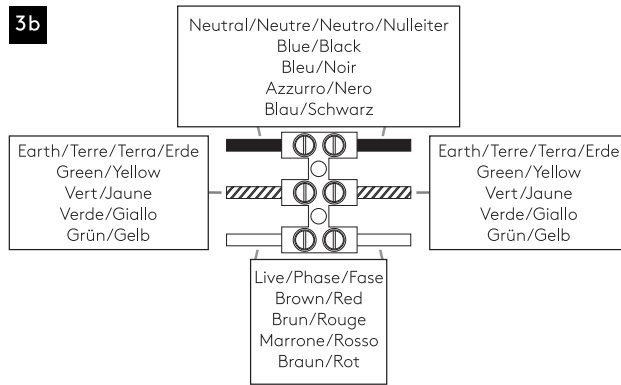

3c

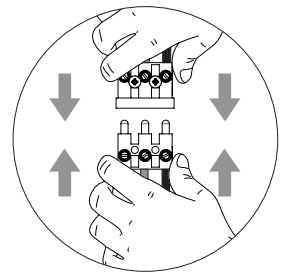

4b

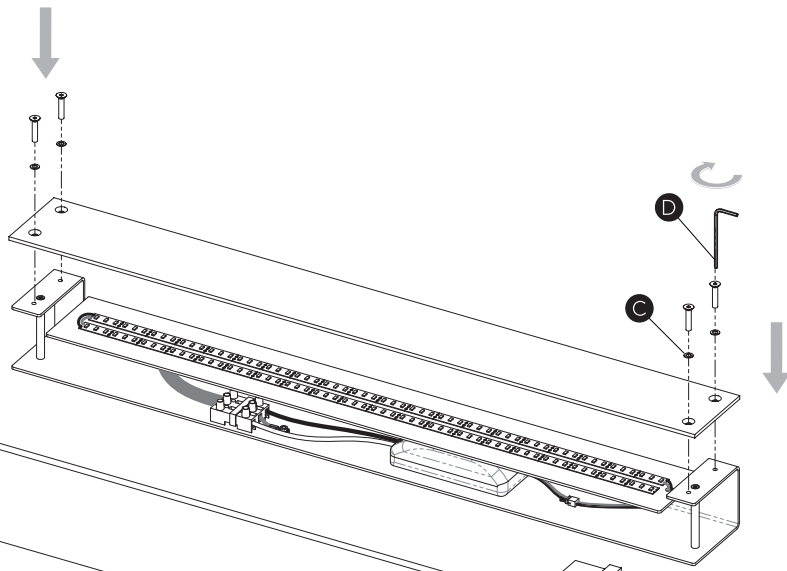

4a

