

Qbini Frame 1X

141710XX

USE INCLUDED CARDBOARD TEMPLATE TO CUT SQUARE HOLE

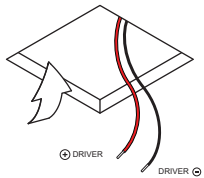
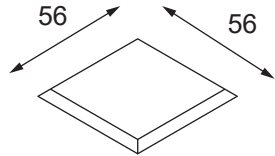
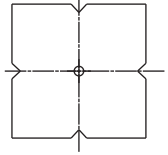

!
CONNECT LED DRIVER TO POWER SUPPLY AND PUT INTO THE CEILING THROUGH HOLE BEFORE INSTALLING FRAME

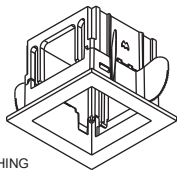

INSTALL FRAME BY PUSHING IN RECESSED HOLE

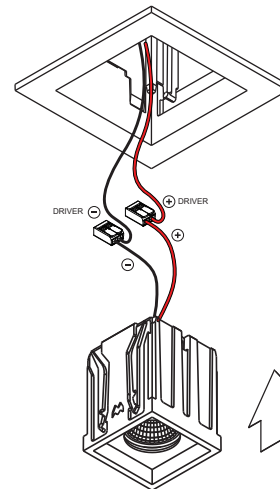
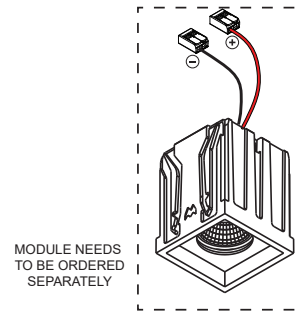
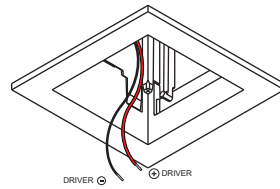
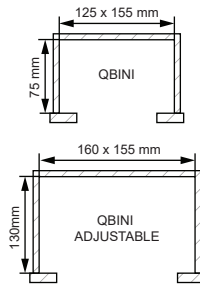

FIRST LATCHED POSITION

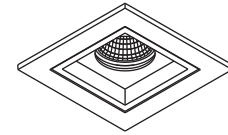

①

PUSH module UP for SECOND LATCHED POSITION

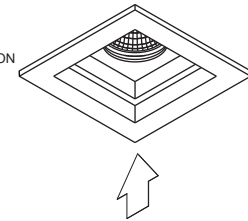

②

PUSH module further UP for RELEASE POSITION

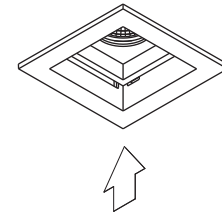

③

PULL module DOWN to remove

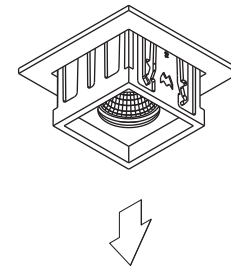

④

