

Smart Lotis 82 IP LED<900L 2,7KM GE

124421XX

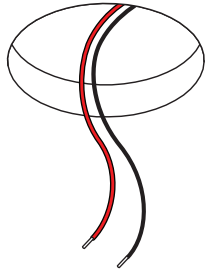

Drive Current (mA)	Forward Voltage		Power (W)
	min (Vf)	max (Vf)	
350	16,5	19,2	6,2
500	17,1	19,8	9,2
For serial connection, respect polarity!			
⊕ RED		⊖ BLACK	

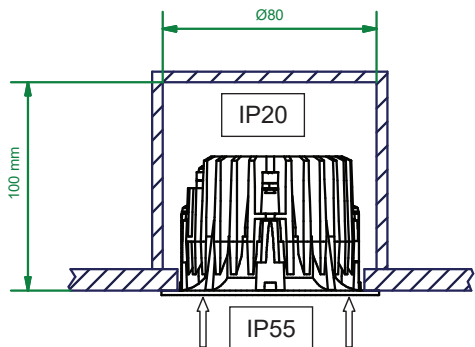
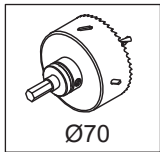

Replace protective shield when broken.
 The luminaire shall only be used complete with its protective shield.
 Reference number: 1010754

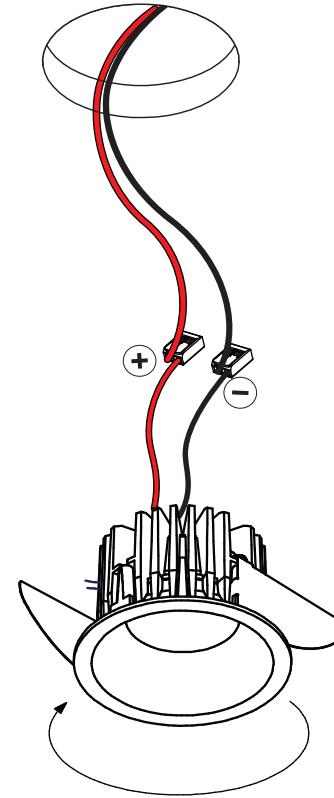
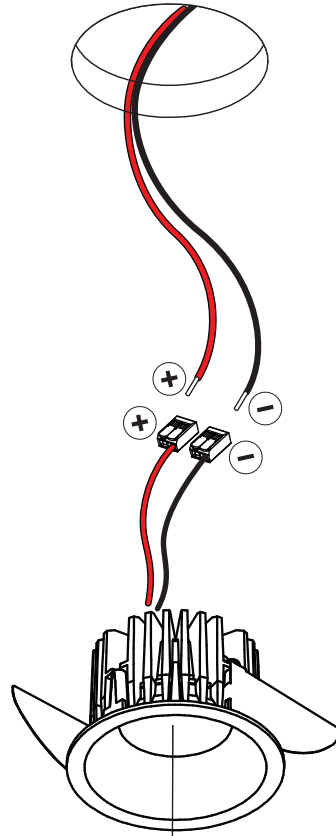

install : Twist clockwise
uninstall : Twist counterclockwise

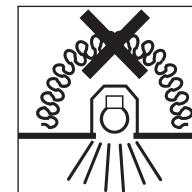

The light source contained in this luminaire shall only be replaced by the manufacturer or his service agent or a similar qualified person

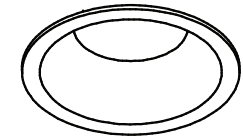

CHECK DIP-SWITCHES ON DRIVER

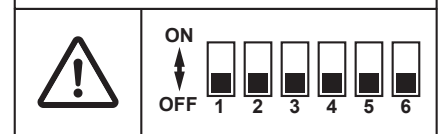

check dipswitch settings on driver
Push Dim max 5 drivers on 1 push button

Drivers:
see driver matrix - latest version on website
www.supermodular.com or check sales contact

