

FLOS

F1595004 Aluminium/Anthracite

Chiara Table

LED retrofit - 10W



Table lamp composed of a reflecting body in aluminium in 3 colour variations, finished internally with an opaque white plastic film and folded and closed via hooks riveted to the sheet metal. A coloured seal in moulded tpu runs along the entire profile of the body. The internal base in extruded aluminium is attached to the body for stability and it also supports the bulb socket. The power cable has a dimmer switch to adjust the brightness. Usable cable length: 1.9 m

Are you a professional and your project needs consulting and support?

[BOOK AN APPOINTMENT](#)

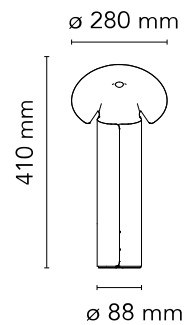

Main specifications

| | |
|-------------------|---------------------|
| EAN | 8059607032305 |
| Mounting | Table |
| Environments | Indoor dry location |
| Light Source Type | Bulb |
| Lamp category | LED retrofit |
| Lamp holders | E14 |
| Ilcos | HSGS |
| Number of heads | 1 |
| Power (W) | 10 |

Physical

| | |
|---------------------|----------------------|
| Colour | Aluminium/Anthracite |
| Cord length (mm) | 1900 |
| Net weight (kg) | 1.32 |
| Package height (mm) | 0 |
| Package width (mm) | 0 |
| Package length (mm) | 0 |
| Package volume (m3) | 0.06 |
| IP internal | 20 |

Download

[Mounting instructions](#)  PDF

[Spare Parts](#)  PDF

Photometric Files

[LDT / IES](#)  LDT



Schematic light drawing

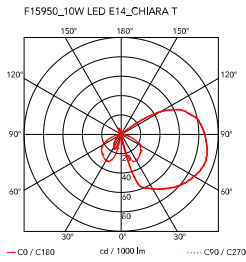

Photometric

| | |
|--------------------|------------|
| Lighting type | Indirect |
| Light distribution | Asymmetric |

Electrical

| | |
|----------------------|-------------------|
| Insulation class | II |
| Frequency (Hz) | 50/60 |
| Main voltage (Vac) | 100-240 |
| LED voltage Vf (Vdc) | null |
| Dimmable | Yes |
| Dimming interface | Dimmer Integrated |
| Plug type | Type C |
| Batteries inside | No |

Bulbs

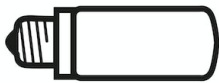

NOT INCLUDED

RF32290

LED Lamp E14 8W 2700K T28

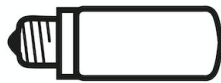

NOT INCLUDED

RF32291

LED Lamp E14 8W 3000K T28



NOT INCLUDED

RF32767

LED Lamp 9W E14 220-240V
2700K T28

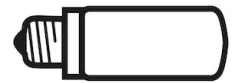

NOT INCLUDED

RF32768

LED Lamp 9W E14 220-240V
3000K T28

Spare Parts

01. Dimmer 4-25W 220-240V Black RF32262

DOWNLOAD

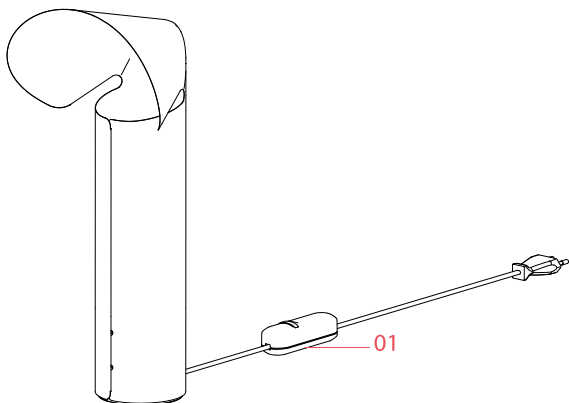



RF32262

Dimmer 4-25W 220-240V Black