



CARE INSTRUCTIONS

Wipe the parts with a damp cloth soaked in warm water and a bit of mild detergent. Use only soft cloth for wiping and polishing, never sponges or steel wool. Do not use abrasive household cleaners. Do not use acidic or alkaline cleaning materials, glass cleaner or household ammonia.

TROUBLESHOOTING

If lamp does not light, turn off the power. Check the bulb for a broken filament. Replace bulb if necessary, then turn it on. If the lamp still does not light, please contact customer service at the local dealer. If the external flexible cable or cord of this lamp is damaged, it must be replaced by a qualified electrician in order to avoid a hazard.

TECHNICAL INFORMATION

Light sources: E27, max. 3x46W halogen bulb (similar to 3x810 Lumen). Best result is achieved with frosted light bulbs with a CRI above 90. Turn power off when changing light bulb. Isolation class II. The lamp is not approved for outdoor use or use in damp/wet rooms (IP20).



For enquiries contact GUBI A/S - CVR: 17940384
Klubiensvej 7-9, 2150 Nordhavn, Copenhagen, Denmark
T +45 69 15 60 60 – salesupport@gubi.dk
GUBI.COM

64-20-002-02 Assembly instructions Tynell Pendant 1965 EU

GUBI

ASSEMBLY INSTRUCTIONS

for

1965 PENDANT

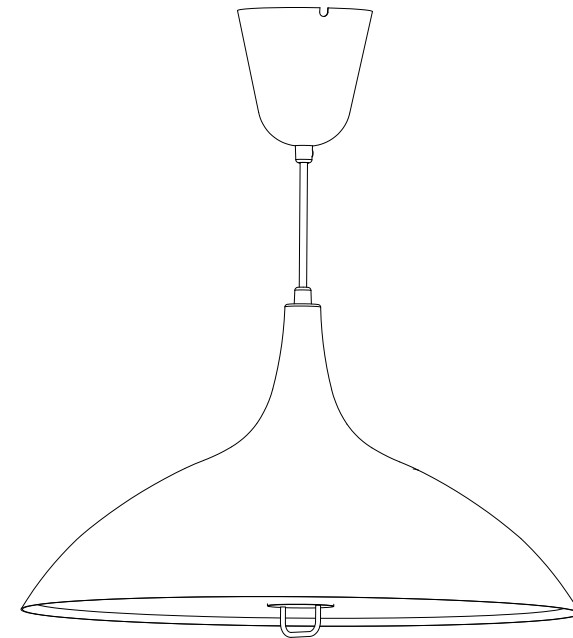

GUBI

ASSEMBLY INSTRUCTIONS

CONTENTS.

PAAVO TYNELL PENDANT 1965

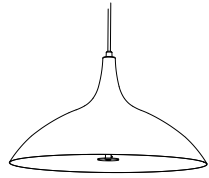

x1

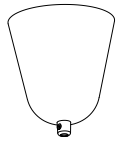

x1

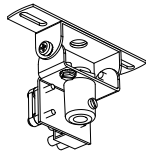

x1

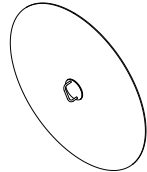

x1

1.

Attach ceiling bracket to the built in outlet or directly on the ceiling with proper screws.

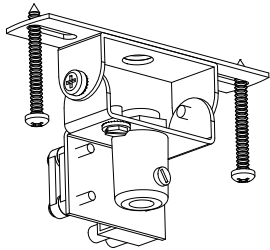

2.

Pull cable through the canopy.

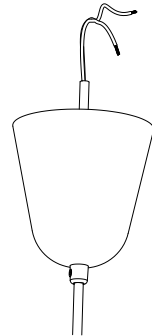

3.

Pull the cable through the cable clamp in the ceiling bracket.

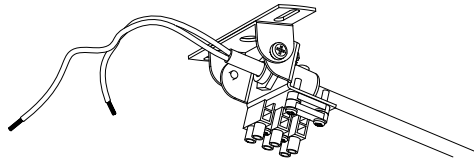

4.

When the right height for the pendant has been found lock the side screw on the cable clamp (a).

By mains outside the canopy connect directly in the outlet (b).

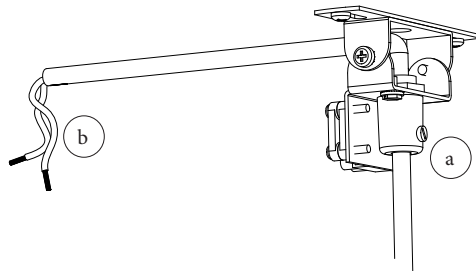

5.

Or cut lamp cable off and connect to terminal connector (a) and extend cable from mains to the other side of the terminal connector.

Do not forget to secure the mains cable in the cable clamp (b).

If ceiling bracket is mounted on a built-in outlet cut lamp cable off and connect to terminal connector (a). Connect mains wires to the other side of the terminal connector (c).

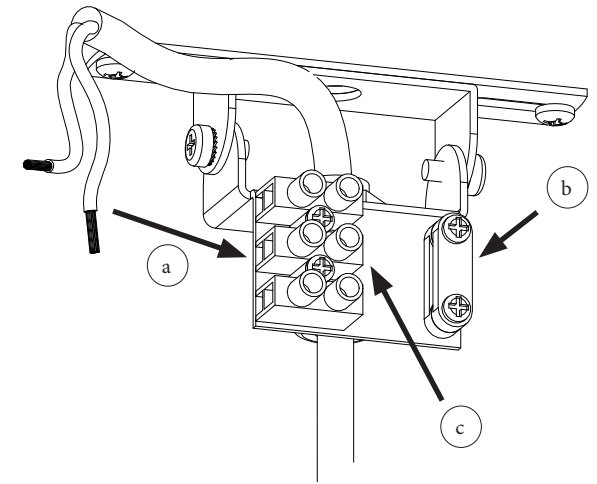

6.

Slide the canopy up the cable and push it against the ceiling while securing it with the side screw (a).

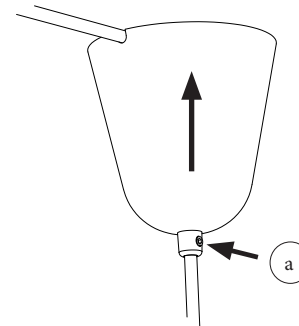

7.

Insert light bulbs in the lamp.

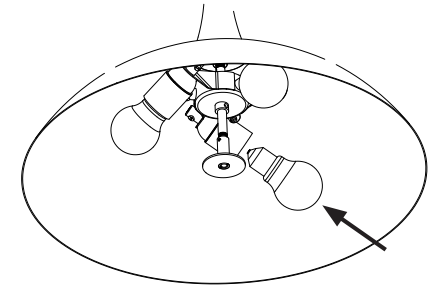

8.

Lift out the glass disc and place it with two hands in center of the lamp. A click will appear and the glass is in place.

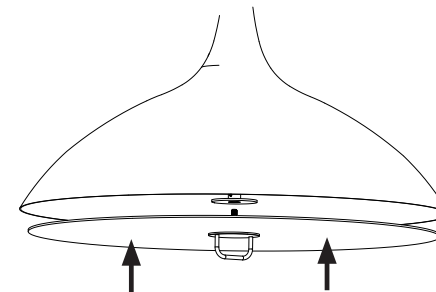

9.

Turn the center handle to secure the glass disc to the lamp.

DO NOT tighten too much since this will break the glass disc.

