

FLOS

F1862033 Argent

Coordinates Suspension 2

Designed by Michael Anastassiades, 2020



55W - 2960lm - 2700K - CRI > 95

Coordinates is a lighting system with diffuse light composed of horizontal and vertical luminaries arranged in a bright grid of various shapes and complexities. Each element is made of extruded anodized aluminium with a champagne or argent finish and a diffuser in platinum optical silicone with an integrated LED strip (CRI 95). Each element is powered and supported by an invisible electrical and mechanical connection designed specifically to allow for the composition of the 4 hanging models (S1, S2, S3, S4) with 2.4-m cables. Each Coordinates configuration includes its own ceiling rose, whose integrated electronics allow for the use of different dimmer systems: push, 1-10, DALI. In the absence of these systems, the amount of light can be set during installation with the push system included in the rose.

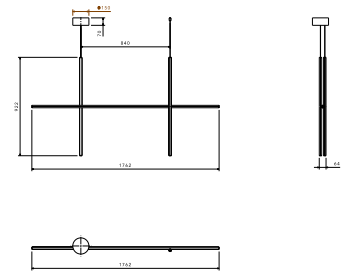

Are you a professional and your project needs consulting and support?

[BOOK AN APPOINTMENT](#)

Main specifications

EAN	8059607038345
Mounting	Suspension
Environments	Indoor dry location
Light Source Type	LED
LED type	LED Module
Power (W)	55
System flux (lm)	2960

Physical

Colour	Argent
Length (mm)	1760
Cord length (mm)	2400
Canopy dimension (mm)	71
Canopy width (mm)	149
Net weight (kg)	2.7
Package height (mm)	0
Package width (mm)	0
Package length (mm)	0
Package volume (m3)	0.03
IP internal	20

Download

[Mounting instructions](#)  PDF

Photometric Files

[ULD](#)  ZIP

Technical Drawings

[3D](#)  ZIP

[Bim](#)  ZIP



Photometric

Lighting type	Total
Light distribution	Asymmetric
CCT (K)	2700
CRI>	95

Electrical

Insulation class	I
Frequency (Hz)	50/60
Main voltage (Vac)	120-240
LED voltage Vf (Vdc)	null
Driver	Integrated
Dimmable	Yes
Dimming type	Dimmable 0-10V, Dimmable Push, Dimmable 1-10V, Dimmable DALI 1
Dimming interface	Remote Dimmable (Dimmer Not Included)
Batteries inside	No

Ecodesign and Energy Labelling

This product contains a light source of energy efficiency class F

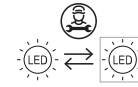

Replaceable (LED only) light source by a professional

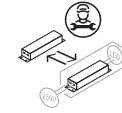

Replaceable control gear by a professional

Spare Parts

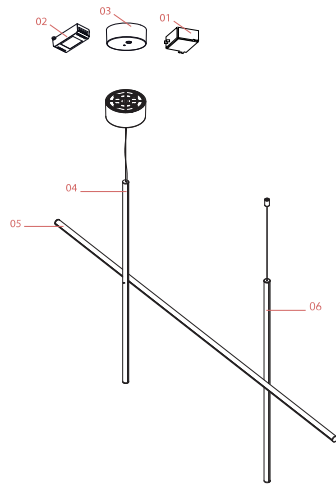

- | | | |
|-----|--|-----------|
| 01. | Power supply kit for Arrangements small & Noctambule | RF0410500 |
| 02. | Led dimmer kit | RF0410300 |
| 03. | Assembly Rose for Coordinates S Argent | RF1872133 |
| 05. | Rod Assembly L1760 H-21 Agent | RF30929 |
| 06. | Rod Assembly L920 SA-20 Agent | RF30928 |
| 10. | Rod Assembly L920 SA-19 Agent | RF30927 |



RF0410500
Power supply kit for
Arrangements small &
Noctambule



RF0410300
Led dimmer kit

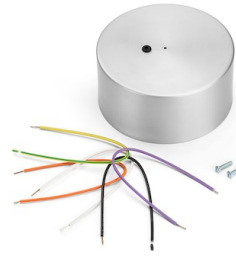

RF1872133
Assembly Rose for Coordinates S
Argent



RF30929
Rod Assembly L1760 H-21 Argent

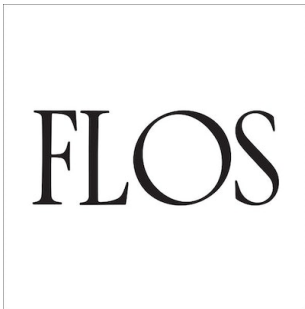

RF30928
Rod Assembly L920 SA-20 Argent

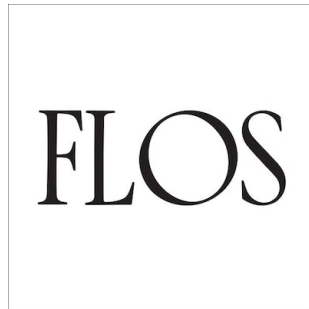

RF30927
Rod Assembly L920 SA-19 Argent