

Argent, a Precious, *Cloud.*

design Dodo Arslan
terzani.com

TERZANI
LA LUCE PENSATA



Type |
Suspension

Materials |
Stainless steel

Finishes | Code

 Stainless Steel
ON90S E7 C8

 Gold plated
ON90S L6 C8

 Black nickel
ON90S E9 C8

Body |

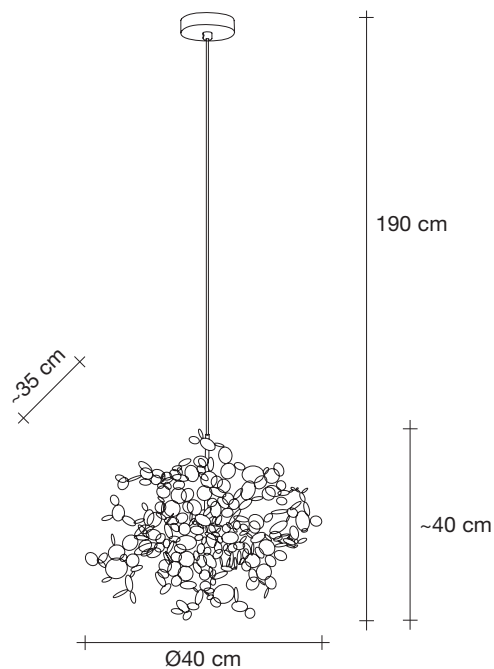

Light Source |

230-240V ~ 50/60Hz

 HALOGEN
3 x 20W G4 12V

 Dimmable with IGBT
Dali system on request

or on request

 LED
3 x 2W G4 12V

 Not Dimmable
Dali system on request

Canopy |

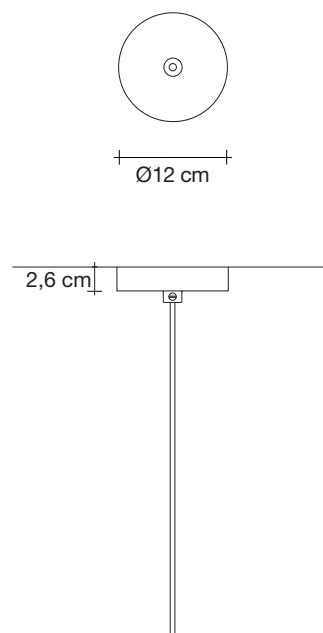

With this new suspension light, designer Dodo Arslan creates a shimmering, silver cloud. Argent consists of metal discs that have been meticulously joined by hand by Terzani craftsmen into clusters. Once lit, the multiple, angled surfaces of the discs emanate a soft, shimmering glow. Design Dodo Arslan.



5,4



2,5



51cm x 51cm x 51cm

Argent, a Precious, *Cloud.*

design Dodo Arslan
terzani.com

TERZANI
LA LUCE PENSATA



Type |
Suspension

Materials |
Stainless steel

Finishes | Code

 Stainless Steel
ON91S E7 C8

 Gold plated
ON91S L6 C8

 Black nickel
ON91S E9 C8

White canopy

Body |

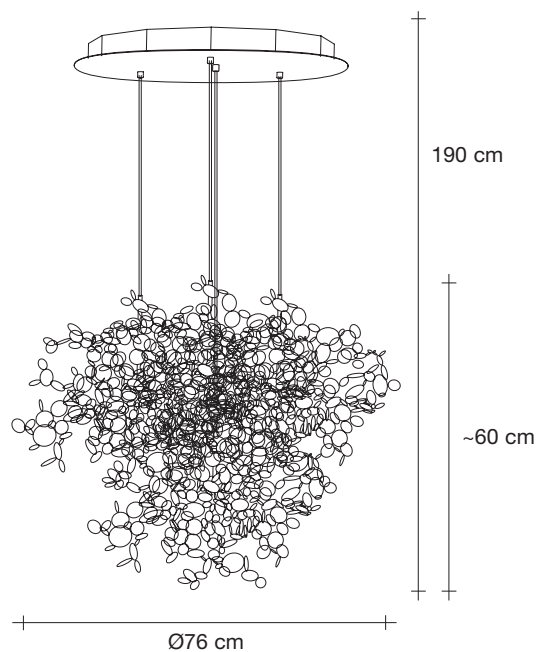

Light Source |

230-240V ~ 50/60Hz

 HALOGEN
12 x 20W G4 12V

 Dimmable with IGBT
Dali system on request

or on request

 LED
12 x 2W G4 12V

 Dimmable with IGBT
Dali system on request

Canopy |

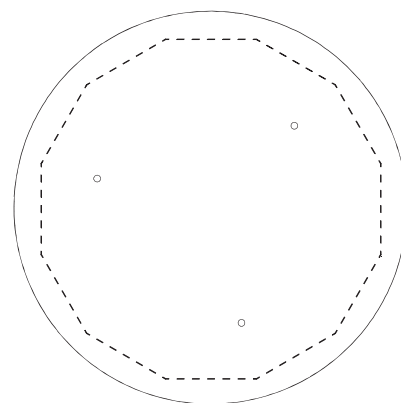
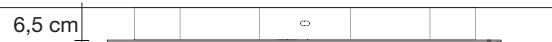

With this new suspension light, designer Dodo Arslan creates a shimmering, silver cloud. Argent consists of metal discs that have been meticulously joined by hand by Terzani craftsmen into clusters. Once lit, the multiple, angled surfaces of the discs emanate a soft, shimmering glow. Design Dodo Arslan.



32



18,5



115cm x 95cm x 75cm

Argent, a Precious, *Cloud.*

design Dodo Arslan
terzani.com

TERZANI
LA LUCE PENSATA



Type |
Suspension

Materials |
Stainless steel

Finishes | Code

 Stainless Steel
ON92S E7 C8

 Gold plated
ON92S L6 C8

 Black nickel
ON92S E9 C8

White canopy

Body |

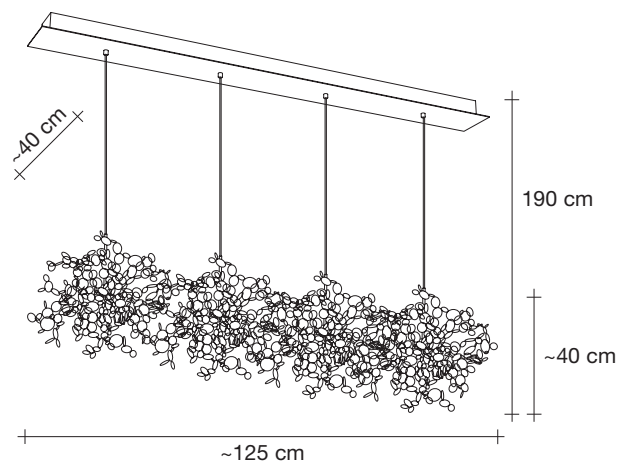

Light Source |

230-240V ~ 50/60Hz

 HALOGEN
12 x 20W G4 12V

 Dimmable with IGBT
Dali system on request

or on request

 LED
12 x 2W G4 12V

 Dimmable with IGBT
Dali system on request

Canopy |

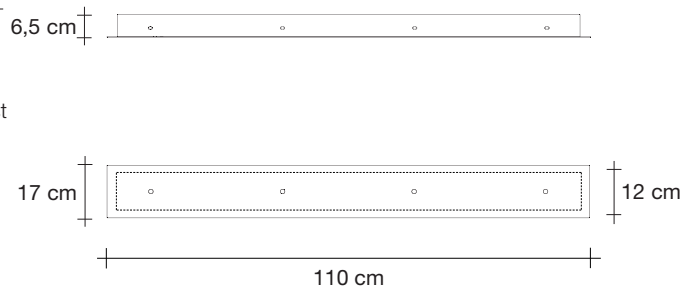

With this new suspension light, designer Dodo Arslan creates a shimmering, silver cloud. Argent consists of metal discs that have been meticulously joined by hand by Terzani craftsmen into clusters. Once lit, the multiple, angled surfaces of the discs emanate a soft, shimmering glow. Design Dodo Arslan.

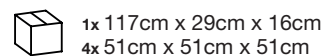
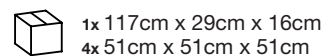

4x 51cm x 51cm x 51cm

Argent, a Precious, *Cloud.*

design Dodo Arslan
terzani.com



TERZANI
LA LUCE PENSATA



Type |
Suspension

Materials |
Stainless steel

Finishes | Code

-  Stainless Steel
ON95S E7 C8
-  Gold plated
ON95S L6 C8

White canopy

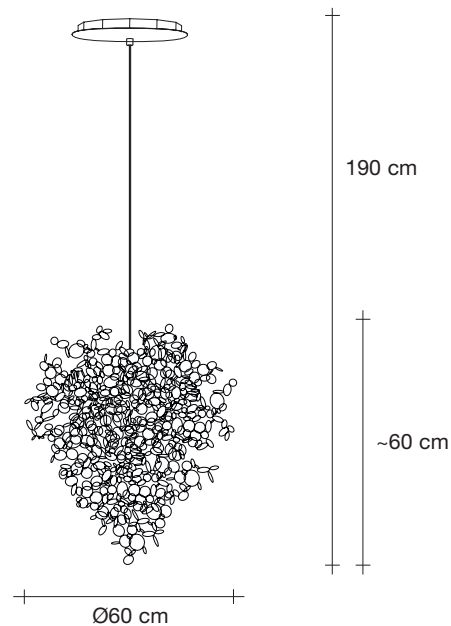

Body |



Canopy |



Light Source |
230-240V ~ 50/60Hz

-  LED integrated
6 x 2,1W
1640 lm
-  Dimmable with 1-10V

With this new suspension light, designer Dodo Arslan creates a shimmering, silver cloud. Argent consists of metal discs that have been meticulously joined by hand by Terzani craftsmen into clusters. Once lit, the multiple, angled surfaces of the discs emanate a soft, shimmering glow. Design Dodo Arslan.

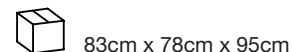
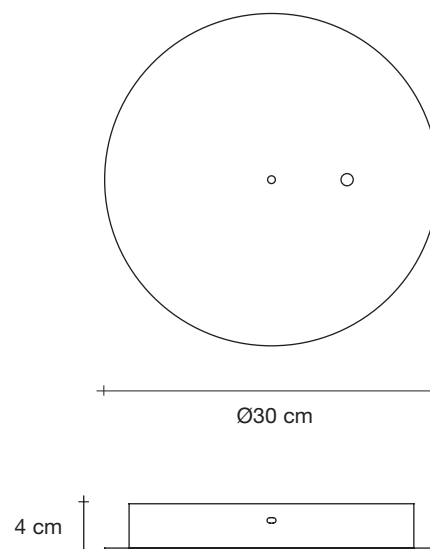

Argent, a Precious, *Cloud.*

design Dodo Arslan
terzani.com

TERZANI
LA LUCE PENSATA



Type |
Suspension

Materials |
Stainless steel



Finishes | Code

-  Stainless Steel
ON93S E7 C8
-  Gold plated
ON93S L6 C8

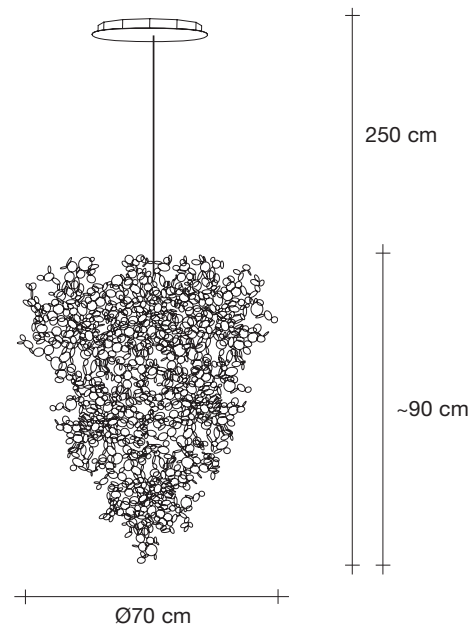
Body |



Light Source |
230-240V ~ 50/60Hz

-  LED integrated
12 x 2,1W
3285 lm
-  Dimmable with 1-10V
and Dali systems only

Canopy |

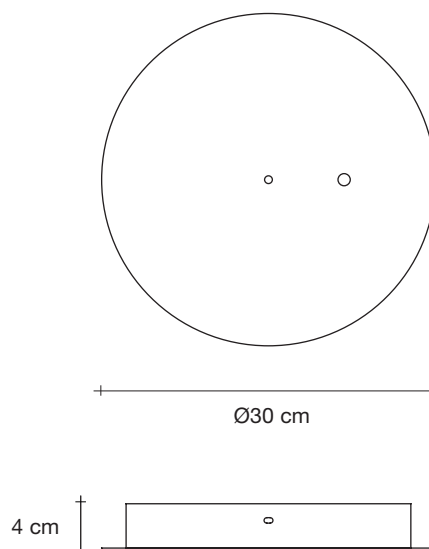

With this new suspension light, designer Dodo Arslan creates a shimmering, silver cloud. Argent consists of metal discs that have been meticulously joined by hand by Terzani craftsmen into clusters. Once lit, the multiple, angled surfaces of the discs emanate a soft, shimmering glow. Design Dodo Arslan.



66



20



82cm x 86cm x 145cm

Argent, a Precious, *Cloud.*

design Dodo Arslan
terzani.com



TERZANI
LA LUCE PENSATA



Type |
Suspension

Materials |
Stainless steel



Finishes | Code

-  Stainless Steel
ON94S E7 C8
-  Gold plated
ON94S L6 C8

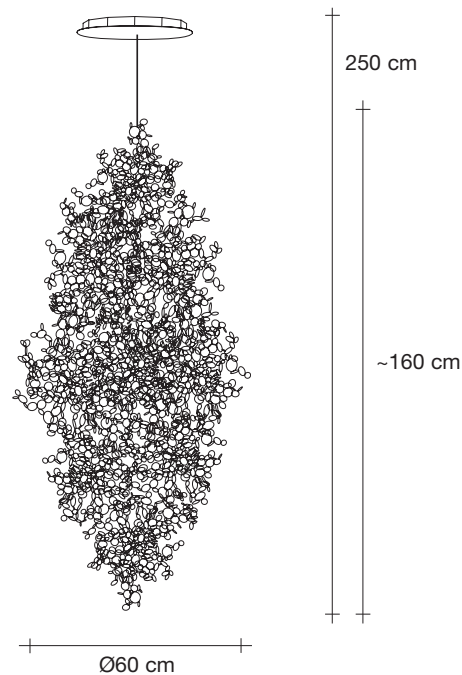
Body |



Light Source |
230-240V ~ 50/60Hz

-  LED integrated
18 x 2,1W
4930 lm
-  Dimmable with 1-10V
and Dali systems only

Canopy |

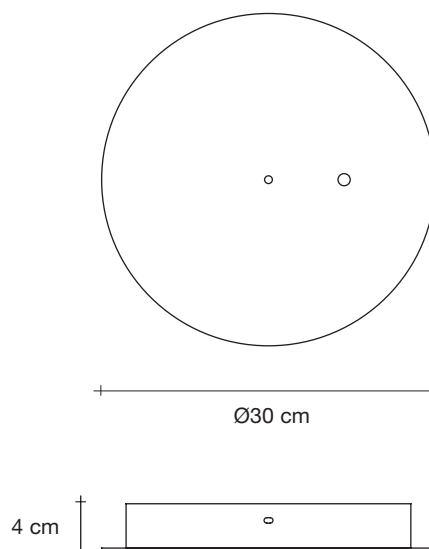

With this new suspension light, designer Dodo Arslan creates a shimmering, silver cloud. Argent consists of metal discs that have been meticulously joined by hand by Terzani craftsmen into clusters. Once lit, the multiple, angled surfaces of the discs emanate a soft, shimmering glow. Design Dodo Arslan.



70



36



80cm x 80cm x 180cm