

FLOS

F3157059 Brass

IC Lights C/W1 Double

Designed by Michael Anastassiades, 2020



Halogen - 2 x 60W - 2700K - CRI> 95

Wall-ceiling lamp providing diffused light. Frame in brass, brushed and transparent varnished or chrome steel. Blown glass opal diffuser.

Are you a professional and your project needs consulting and support?

[BOOK AN APPOINTMENT](#)

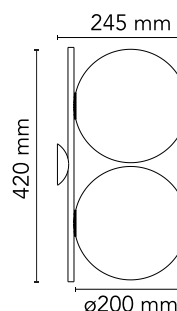

Main specifications

EAN	8059607000069
Mounting	Ceiling and wall surface
Environments	Indoor dry location
Light Source Type	Bulb
Lamp category	Halogen
Lamp holders	E14
Iicos	HSGS
Number of heads	2
Power (W)	60

Physical

Colour	Brass
Length (mm)	245
Net weight (kg)	2.3
Package height (mm)	0
Package width (mm)	0
Package length (mm)	0
Package volume (m3)	0.06
IP internal	20

Download

[Mounting instructions](#)  PDF

[Spare Parts](#)  PDF

Photometric Files

[LDT / IES](#)  LDT

Technical Drawings

[Bim](#)  ZIP



IK	IP
07	20

Schematic light drawing

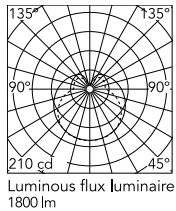

Photometric

Lighting type	Total
Light distribution	Symmetric
CCT (K)	2700
CRI>	95

Electrical

Insulation class	I
Frequency (Hz)	50/60
Main voltage (Vac)	220-250
Dimmable	Yes
Dimming interface	Remote Dimmable (Dimmer Not Included)
Batteries inside	No

Bulbs

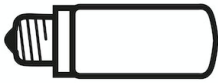

NOT INCLUDED

RF32290

LED Lamp E14 8W 2700K T28

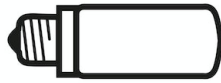

NOT INCLUDED

RF32291

LED Lamp E14 8W 3000K T28

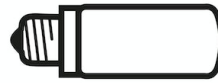

NOT INCLUDED

RF32767

LED Lamp 9W E14 220-240V
2700K T28



NOT INCLUDED

RF32768

LED Lamp 9W E14 220-240V
3000K T28

Spare Parts

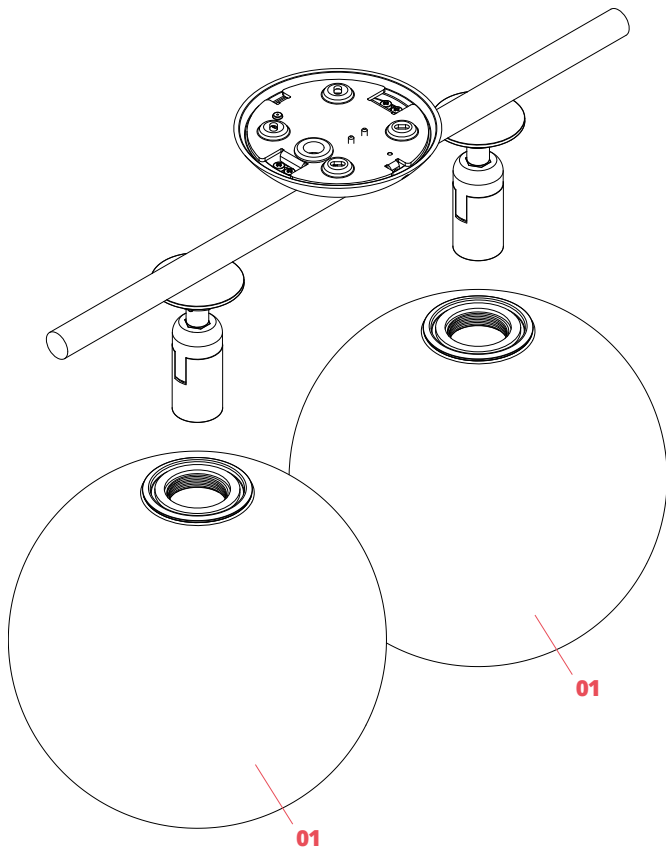

- 01. IC Lights 1 diffuser for brass version F3136059
- 02. Kit with screws and allen key RF3160100

DOWNLOAD



F3136059

IC Lights 1 diffuser for brass
version



RF3160100

Kit with screws and allen key